

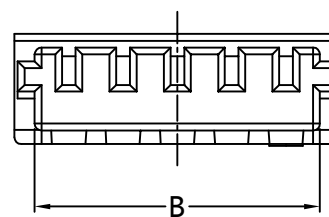

PART NUMBER CODING

H08001-1 XX X 2

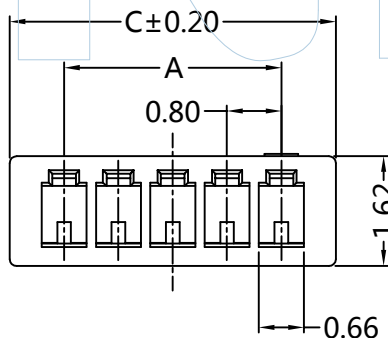
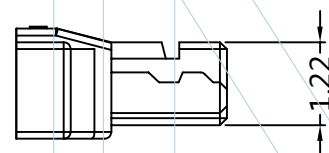
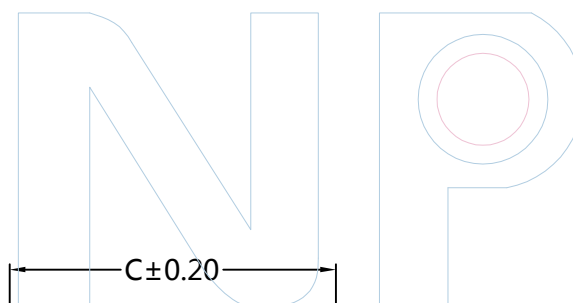
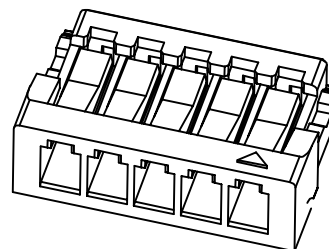
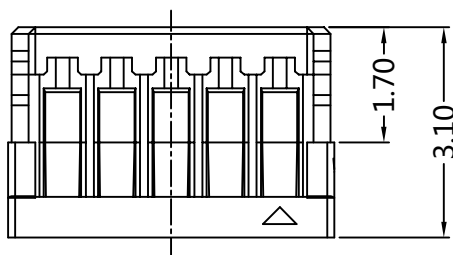
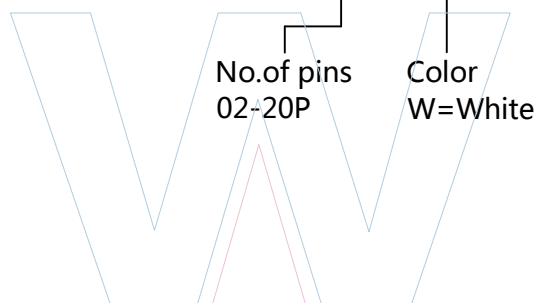

Dimensions(mm)

POLES	A	B	C	POLES	A	B	C
2P	0.80	1.80	2.40	12P	8.80	9.80	10.40
3P	1.60	2.60	3.20	13P	9.60	10.60	11.20
4P	2.40	3.40	4.00	14P	10.40	11.40	12.00
5P	3.20	4.20	4.80	15P	11.20	12.20	12.80
6P	4.00	5.00	5.60	16P	12.00	13.00	13.60
7P	4.80	5.80	6.40	17P	12.80	13.80	14.40
8P	5.60	6.60	7.20	18P	13.60	14.60	15.20
9P	6.40	7.40	8.00	19P	14.40	15.40	16.00
10P	7.20	8.20	8.80	20P	15.20	16.20	16.80
11P	8.00	9.00	9.60				



Tel:+86 769 82581808 FAX:+86 769 81766192
E-Mail:sales@winpin.net Http:www.winpin.net

PART NO: H08001-1XXX2

TITLE: 0.8mm Crimp Housing 无耳

NOTES:
Current Rating:0.5A
Withstand Voltage:200V AC/DC
Rated Voltage:30V AC/DC
Contact Resistance:20mΩ Max
Insulation Resistance:100MΩ Min
Operation Temperature:-40°C to +105°C
Applicable Terminal:T08001-PXX2

Insulator Material:PA46 (UL94V-0)

UNLESS OTHERWISE SPECIFIED DIMENSIONS ARE IN METRIC
TOLERANCES ARE:
DECIMALS Angle
X.X:±0.40 ± 3°
X.XX:±0.25
X.XXX:±0.15

SCALE	1:1
UNIT	MM
PROJ.	
SHEET	

A0	2020/06/25	NEW	Jason.Huang		Jason.Huang
REV	DATE	MODIFICATION DESCRIPTIO	DRAW	CHANGE	APPROVE



PART NUMBER CODING T08001-P XX 2

- Contact plating
 G0:Gold Flash
 G1:3U"Gold
 G2:5U"Gold
 G3:10U"Gold
 G4:15U"Gold
 G5:20U"Gold
 G6:30U"Gold
 S0:Gold Flash/Tin
 S1:3U"Gold/Tin
 S2:5U"Gold/Tin
 S3:10U"Gold/Tin
 S4:15U"Gold/Tin
 S6:30U"Gold/Tin
 SN:Tin

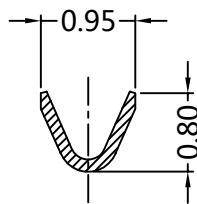
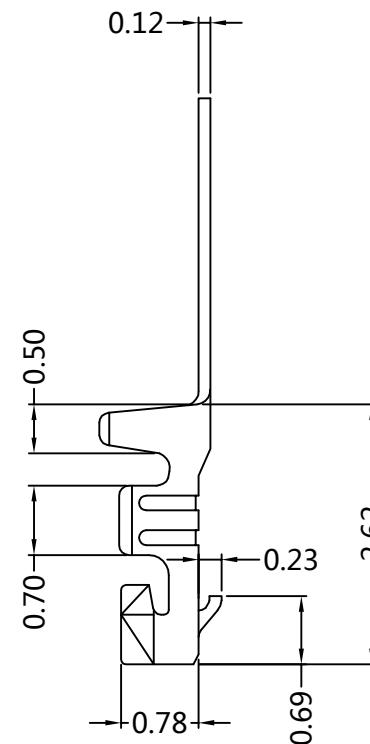
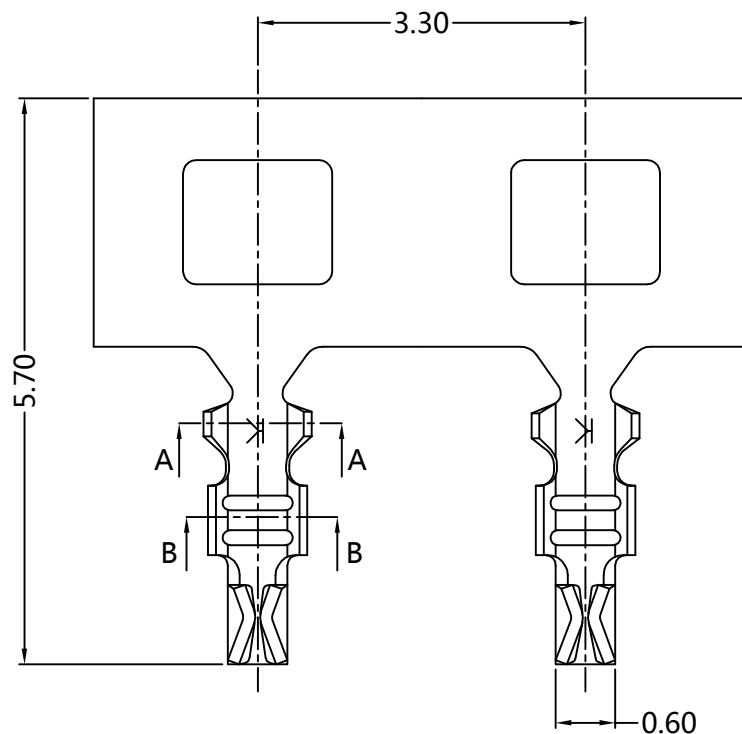

SECTION: B-B

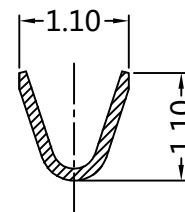

SECTION: A-A



Tel: +86 769 82581808 FAX: +86 769 81766192
 E-Mail: sales@winpin.net Http: www.winpin.net

PART NO: T08001-PXX2

TITLE: 0.8mm Crimp terminal

NOTES:
 Current Rating:1.5A
 Withstand Voltage:500V AC/DC
 Rated Voltage:50V AC/DC
 Contact Resistance:20mΩ Max
 Insulation Resistance:100MΩ Min
 Operation Temperature:-40°C to +105°C
 Applicable Wires:AWG#32(OD 0.60MAX.)
 Applicable Housing: H08001-1XXX2

Material: Phosphor Bronze
 Finish: Tin plated

UNLESS OTHERWISE SPECIFIED DIMENSIONS ARE IN METRIC
 TOLERANCES ARE:
 DECIMALS Angle
 X.X:±0.40 ± 3°
 X.XX:±0.25
 X.XXX:±0.15

SCALE	1:1
UNIT	MM
PROJ.	
SHEET	

A0	2020/06/25	NEW	Jason.Huang		Jason.Huang
REV	DATE	MODIFICATION DESCRIPTO	DRAW	CHANGE	APPROVE



PART NUMBER CODING

W08001-1 XX M XX X X 2

No.of pins
2-20

Contact plating
G0:Gold Flash
SN:Tin

Color
E=BRIGE

Packing
R=Tape&Reel+CAP

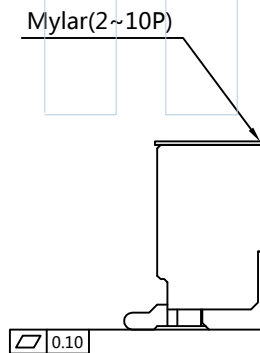
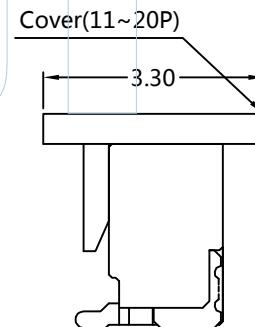
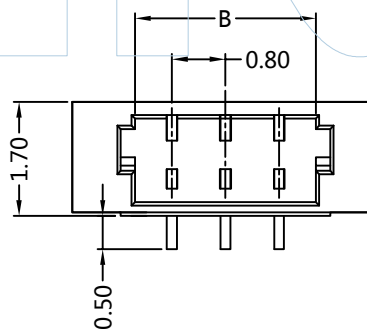
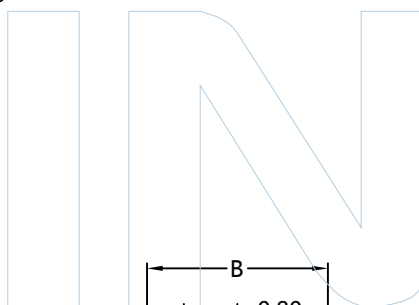
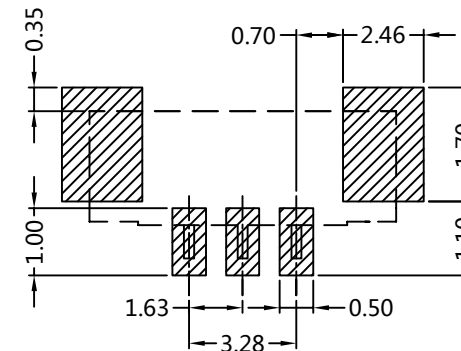
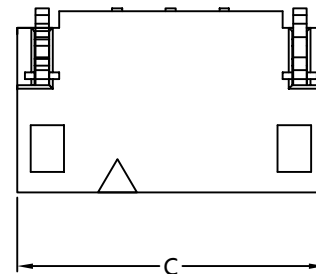
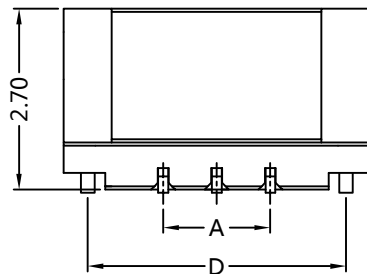
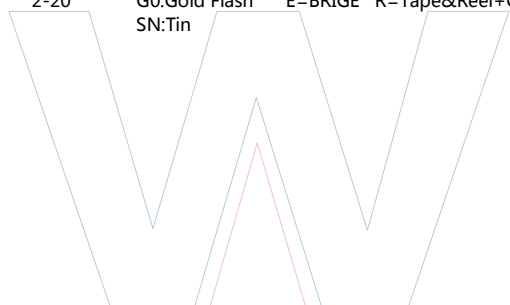

Recommended P.C.B Layout(Top Side)
(PCB BOARD TOLERANCE±0.05)

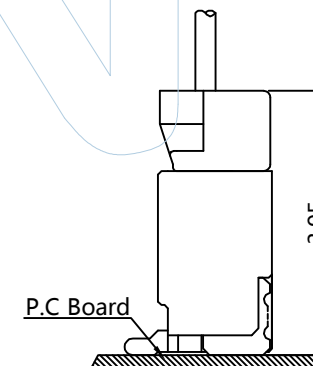

Dimensions(mm)									
POLES	A	B	C	D	POLES	A	B	C	D
2P	0.80	1.90	3.78	3.04	12P	8.80	9.90	11.78	11.04
3P	1.60	2.70	4.58	3.84	13P	9.60	10.70	12.58	11.84
4P	2.40	3.50	5.38	4.64	14P	10.40	11.50	13.38	12.64
5P	3.20	4.30	6.18	5.44	15P	11.20	12.30	14.18	13.44
6P	4.00	5.10	6.98	6.24	16P	12.00	13.10	14.98	14.25
7P	4.80	5.90	7.78	7.04	17P	12.80	13.90	15.78	15.04
8P	5.60	6.70	8.58	7.84	18P	13.60	14.70	16.58	15.84
9P	6.40	7.50	9.38	8.64	19P	14.40	15.50	17.38	16.64
10P	7.20	8.30	10.18	9.44	20P	15.20	16.30	18.18	17.44
11P	8.00	9.10	10.98	10.24					



Tel:+86 769 82581808 FAX:+86 769 81766192
E-Mail:sales@winpin.net Http:www.winpin.net

PART NO: W08001-1XXMXXXX2

TITLE: SUR 0.80mm Wafer Connectors 180°SMT Type

NOTES:
Current Rating:0.5AMP
Withstand Voltage:200V AC/DC
Rated Voltage:30V AC/DC
Contact Resistance:20mΩ Max
Insulation Resistance:100MΩ Min
Operation Temperature:-25°C to +85°C
Applicable Housing:H08001-1XXXX
Applicable Terminal:T08001-PXX2

Material
Contact PIN: Phosphor bronze
Solder tab: Beass
Contact Plating:Au or Sn over Ni
Solder tab Plating:Au or Sn over Ni
Insulator Material:LCP(UL94V-0)

UNLESS OTHERWISE SPECIFIED DIMENSIONS ARE IN METRIC
TOLERANCES ARE:
DECIMALS Angle
X.X:±0.40 ± 3°
X.XX:±0.25
X.XXX:±0.15

SCALE	1:1
UNIT	MM
PROJ.	
SHEET	

A0	2022/10/25	NEW	NiKe.Tan	Andy	
REV	DATE	MODIFICATION DESCRIPTIO	DRAW	CHANGE	APPROVE



PART NUMBER CODING

W08001-1 XX Z XX X X 2

No.of pins: 2-20
 Contact plating: G0:Gold Flash, SN:Tin
 Color: E=BRIGE
 Packing: R=Tape&Reel+CAP

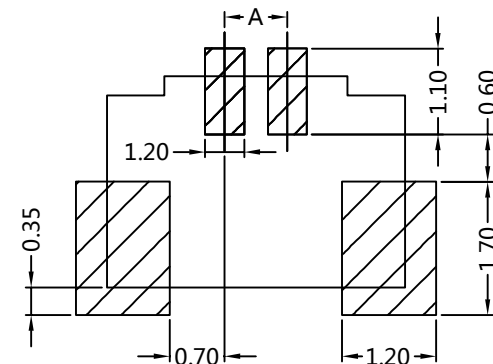
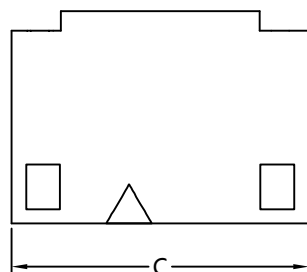

Recommended P.C.B Layout(Top Side)
 (PCB BOARD TOLERANCE±0.05)

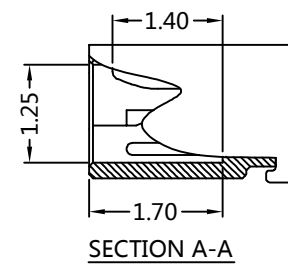
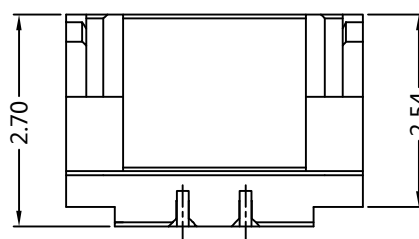
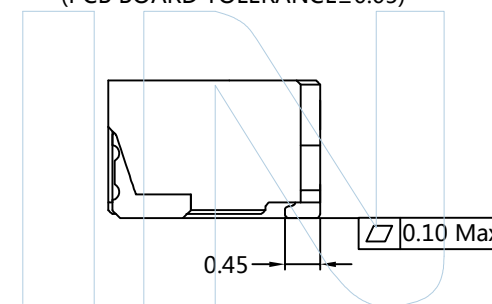
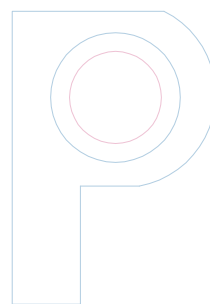
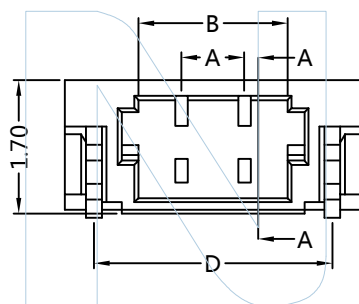
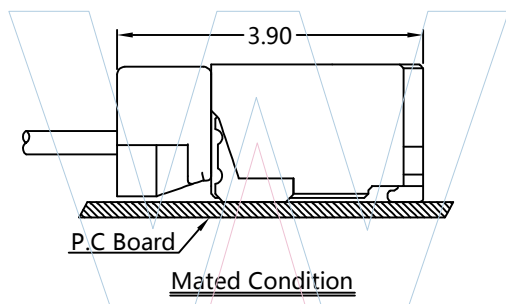

Dimensions(mm)									
POLES	A	B	C	D	POLES	A	B	C	D
2P	0.80	1.90	3.78	3.04	12P	8.80	9.90	11.78	11.04
3P	1.60	2.70	4.58	3.84	13P	9.60	10.70	12.58	11.84
4P	2.40	3.50	5.38	4.64	14P	10.40	11.50	13.38	12.64
5P	3.20	4.30	6.18	5.44	15P	11.20	12.30	14.18	13.44
6P	4.00	5.10	6.98	6.24	16P	12.00	13.10	14.98	14.25
7P	4.80	5.90	7.78	7.04	17P	12.80	13.90	15.78	15.04
8P	5.60	6.70	8.58	7.84	18P	13.60	14.70	16.58	15.84
9P	6.40	7.50	9.38	8.64	19P	14.40	15.50	17.38	16.64
10P	7.20	8.30	10.18	9.44	20P	15.20	16.30	18.18	17.44
11P	8.00	9.10	10.98	10.24					



Tel:+86 769 82581808 FAX:+86 769 81766192
 E-Mail:sales@winpin.net Http:www.winpin.net

PART NO: W08001-1XXZXXXX2

TITLE: SUR 0.80mm Wafer Connectors 90°SMT Type

NOTES:
 Current Rating:0.5AMP
 Withstand Voltage:200V AC/DC
 Rated Voltage:30V AC/DC
 Contact Resistance:20mΩ Max
 Insulation Resistance:100MΩ Min
 Operation Temperature:-40°C to +105°C
 Applicable Housing:H08001-1XXXX
 Applicable Terminal:T08001-PXX2

Material
 Contact PIN: Phosphor bronze
 Solder tab: Beass
 Contact Plating:Au or Sn over Ni
 Solder tab Plating:Au or Sn over Ni
 Insulator Material:LCP(UL94V-0)

UNLESS OTHERWISE SPECIFIED DIMENSIONS ARE IN METRIC
 TOLERANCES ARE:
 DECIMALS Angle
 X.X:±0.40 ± 3°
 X.XX:±0.25
 X.XXX:±0.15

SCALE	1:1
UNIT	MM
PROJ.	
SHEET	

A0	2022/10/25	NEW	NiKe.Tan	Andy	
REV	DATE	MODIFICATION DESCRIPTIO	DRAW	CHANGE	APPROVE