



03P-12P

02P

4.58±0.2

PART NUMBER CODING

H30001-1 XX X 1

No. of pins
02-12P

Color
B=Black

Pins	Dimensions	
	A	B
2	3.00	6.85
3	6.00	9.85
4	9.00	12.85
5	12.00	15.85
6	15.00	18.85
7	18.00	21.85
8	21.00	24.85
9	24.00	27.85
10	27.00	30.85
11	30.00	33.85
12	33.00	36.85

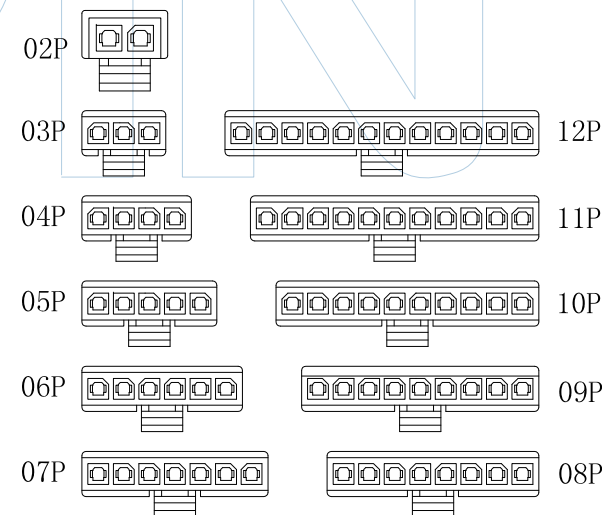
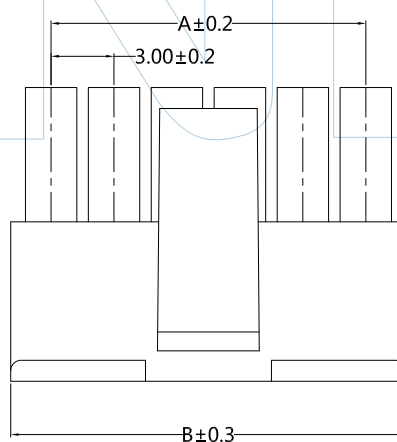
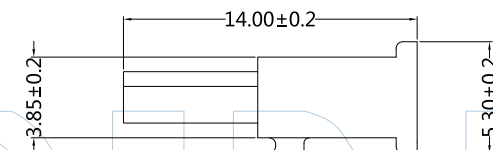
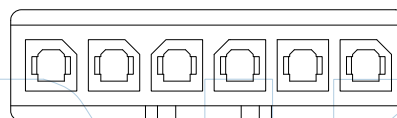
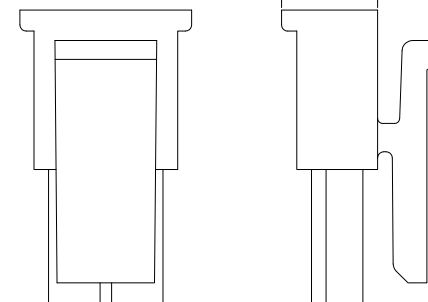
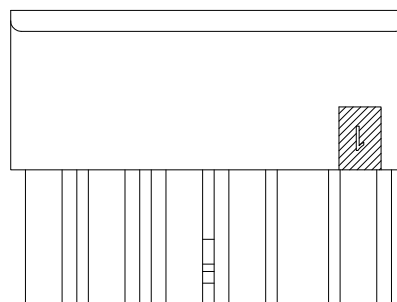

Tel: +86 769 82581808 FAX: +86 769 81766192
E-Mail: sales@winpin.net Http: www.winpin.net

NOTES:
Current Rating: 5.0AMP
Voltage Rating: 250V AC, DC
Withstand Voltage: 1500V AC/Minute
Contact Resistance: 10mΩ Max
Insulation Resistance: 1000MΩ Min
Operation Temperature: -40°C to +105°C
Applicable Terminal: T30001-PXX5

Material:
Insulator Material: PA66 (UL94V-2)

UNLESS OTHERWISE SPECIFIED DIMENSIONS ARE IN METRIC
TOLERANCES ARE:
DECIMALS Angle
X.X: ±0.40 ± 3°
X.XX: ±0.25
X.XXX: ±0.15

PART NO: H30001-1XXX1

TITLE: MX3.0mm Housing

SCALE	1:1
UNIT	MM
PROJ.	
SHEET	

A0	2020/06/25	NEW	Jason.Huang		Jason.Huang
REV	DATE	MODIFICATION DESCRIPTION	DRAW	CHANGE	APPROVE



03P-12P

02P

4.58±0.2

PART NUMBER CODING

H30001-1 XX X 5

No. of pins
02-12P

Color
B=Black

Pins	Dimensions	
	A	B
2	3.00	6.85
3	6.00	9.85
4	9.00	12.85
5	12.00	15.85
6	15.00	18.85
7	18.00	21.85
8	21.00	24.85
9	24.00	27.85
10	27.00	30.85
11	30.00	33.85
12	33.00	36.85

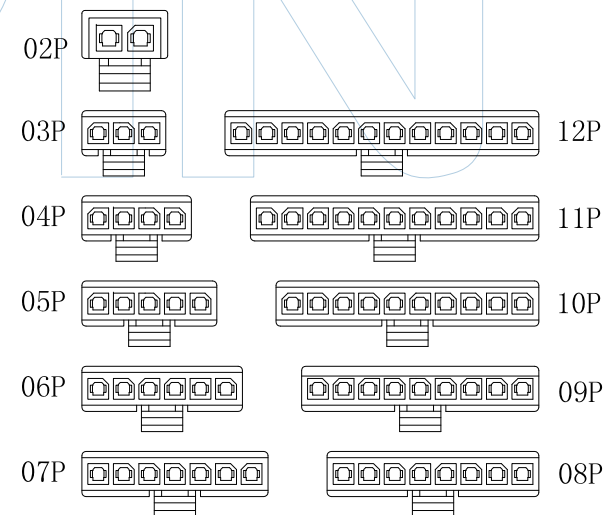
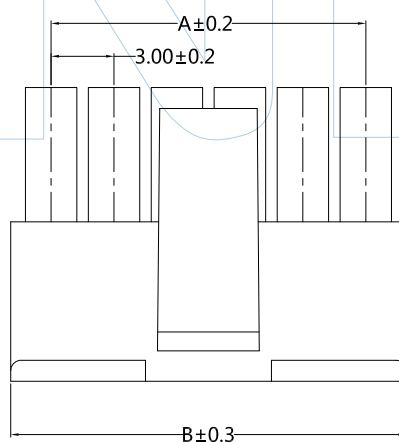
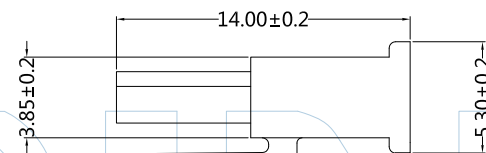
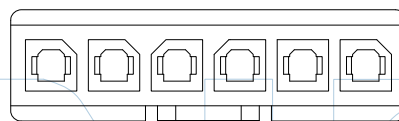
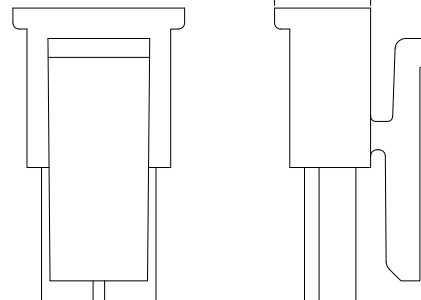
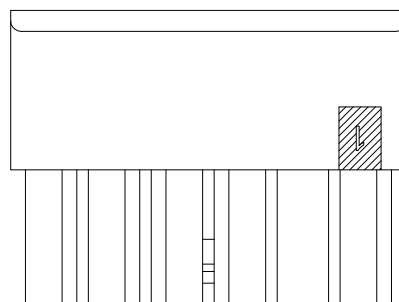

Tel: +86 769 82581808 FAX: +86 769 81766192
E-Mail: sales@winpin.net Http: www.winpin.net

NOTES:
Current Rating: 5.0AMP
Voltage Rating: 250V AC/DC
Withstand Voltage: 1500V AC/Minute
Contact Resistance: 10mΩ Max
Insulation Resistance: 1000MΩ Min
Operation Temperature: -40°C to +105°C
Applicable Terminal: T30001-PXX5

Material:
Insulator Material: PA66 (UL94V-0)

UNLESS OTHERWISE SPECIFIED DIMENSIONS ARE IN METRIC
TOLERANCES ARE:
DECIMALS Angle
X.X: ±0.40 ± 3°
X.XX: ±0.25
X.XXX: ±0.15

SCALE	1:1
UNIT	MM
PROJ.	
SHEET	

PART NO: H30001-1XXX5

TITLE: MX3.0mm Housing

A0	2020/06/25	NEW	Jason.Huang		Jason.Huang
REV	DATE	MODIFICATION DESCRIPTIO	DRAW	CHANGE	APPROVE

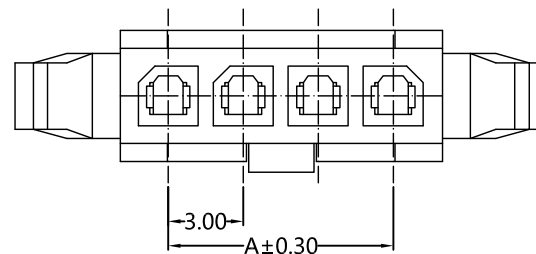
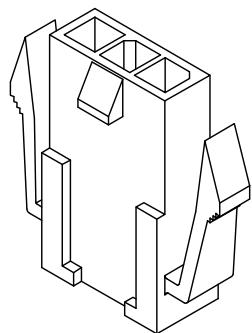

PART NUMBER CODING

H30001-1 XX B X

No. of pins 02-12P
 Color B=Black
 Series No. 2: With Mounting ears
 3: W/O Mounting ears

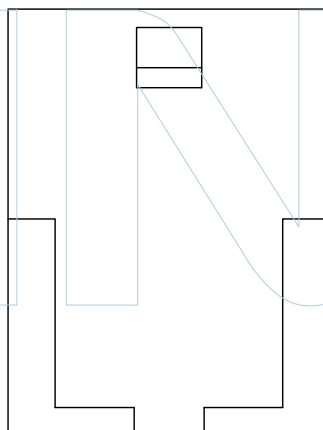

3: W/O Mounting ears

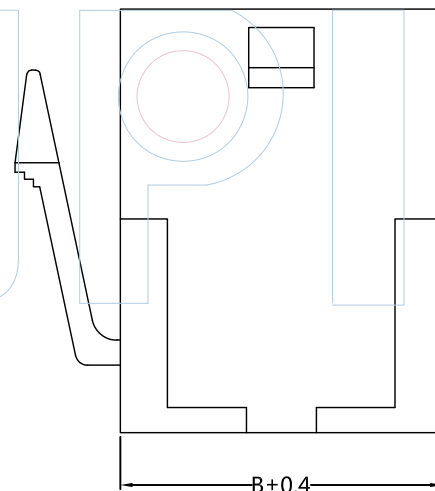

2: With Mounting ears

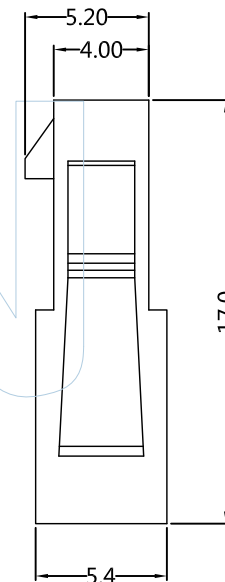

Pins	Dimensions	
	A	B
2	3.00	7.00
3	6.00	10.00
4	9.00	13.00
5	12.00	16.00
6	15.00	19.00
7	18.00	22.00
8	21.00	25.00
9	24.00	28.00
10	27.00	31.00
11	30.00	34.00
12	33.00	37.00



Tel: +86 769 82581808 FAX: +86 769 81766192
 E-Mail: sales@winpin.net Http://www.winpin.net

PART NO: H30001-1XXB

TITLE: 3.0mm Single Row Housing

NOTES:
 Current Rating: 5.0AMP
 Voltage Rating: 250V AC, DC
 Withstand Voltage: 1500V AC/Minute
 Contact Resistance: 10mΩ Max
 Insulation Resistance: 1000MΩ Min
 Operation Temperature: -40°C to +105°C
 Applicable Terminal: T30001-PXX1

Material:
 Insulator Material: PA66 (UL94V-2)

UNLESS OTHERWISE SPECIFIED DIMENSIONS ARE IN METRIC TOLERANCES ARE:
 DECIMALS Angle
 X.X: ±0.40 ± 3°
 X.XX: ±0.25
 X.XXX: ±0.15

SCALE	1:1
UNIT	MM
PROJ.	
SHEET	

A0	2015/06/25	NEW	Hua.ZT		Hua.ZT
REV	DATE	MODIFICATION DESCRIPTION	DRAW	CHANGE	APPROVE

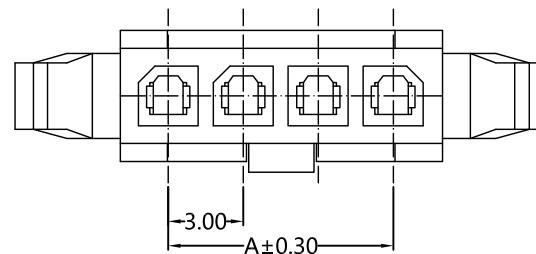
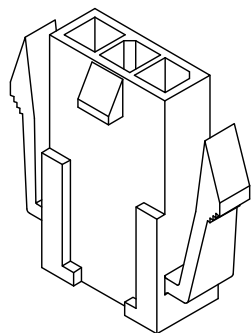

PART NUMBER CODING

H30001-1 XX B X

No. of pins
02-12P

Color
B=Black

Series No.
2: With Mounting ears
3: W/O Mounting ears

Pins	Dimensions	
	A	B
2	3.00	7.00
3	6.00	10.00
4	9.00	13.00
5	12.00	16.00
6	15.00	19.00
7	18.00	22.00
8	21.00	25.00
9	24.00	28.00
10	27.00	31.00
11	30.00	34.00
12	33.00	37.00

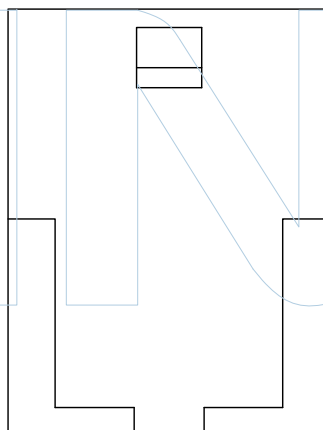

3: W/O Mounting ears

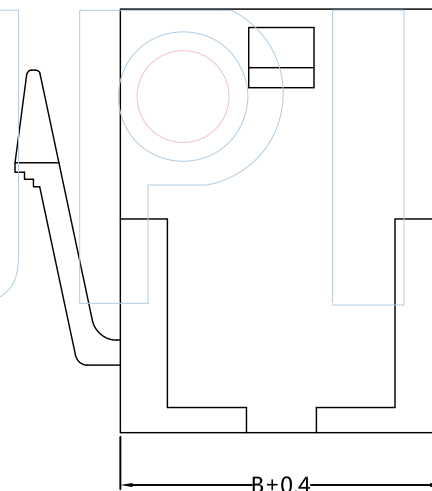

2: With Mounting ears

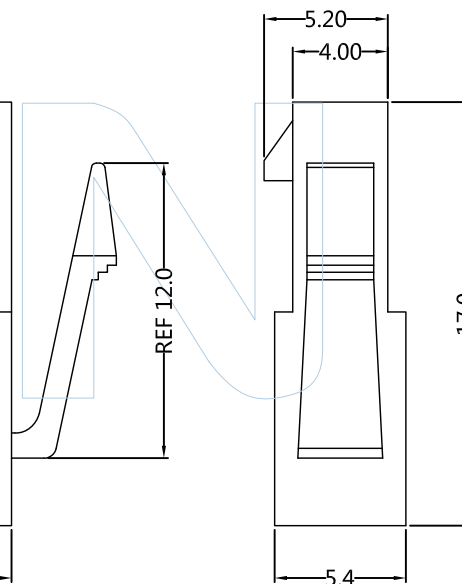

Tel: +86 769 82581808 FAX: +86 769 81766192
E-Mail: sales@winpin.net Http: www.winpin.net

PART NO: H30001-1XXB

TITLE: 3.0mm Single Row Housing

NOTES:
Current Rating: 5.0AMP
Voltage Rating: 250V AC, DC
Withstand Voltage: 1500V AC/Minute
Contact Resistance: 10mΩ Max
Insulation Resistance: 1000MΩ Min
Operation Temperature: -40°C to +105°C
Applicable Terminal: T30001-PXX1

Material:
Insulator Material: PA66 (UL94V-2)

UNLESS OTHERWISE SPECIFIED DIMENSIONS ARE IN METRIC TOLERANCES ARE:
DECIMALS Angle
X.X: ±0.40 ± 3°
X.XX: ±0.25
X.XXX: ±0.15

SCALE	1:1
UNIT	MM
PROJ.	
SHEET	

A0	2015/06/25	NEW	Hua.ZT		Hua.ZT
REV	DATE	MODIFICATION DESCRIPTION	DRAW	CHANGE	APPROVE

PART NUMBER CODING
T30002-P XX 2

Contact plating
SN: Tin

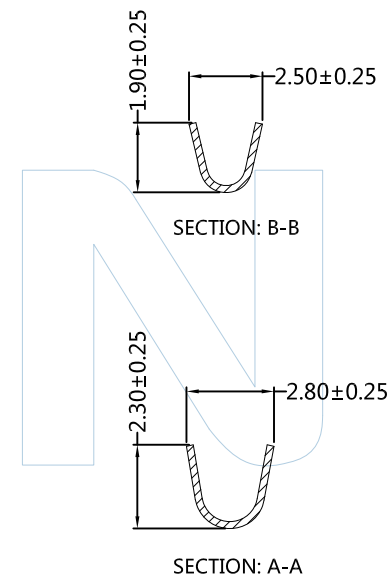
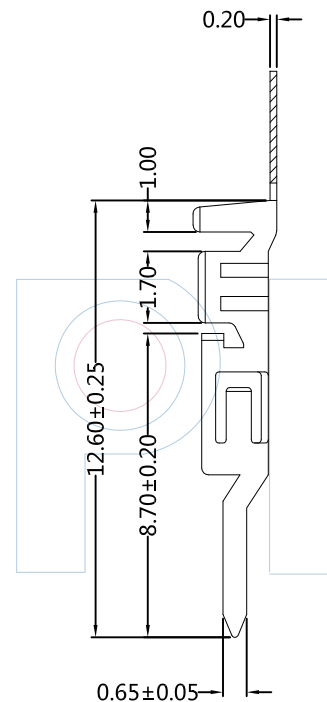
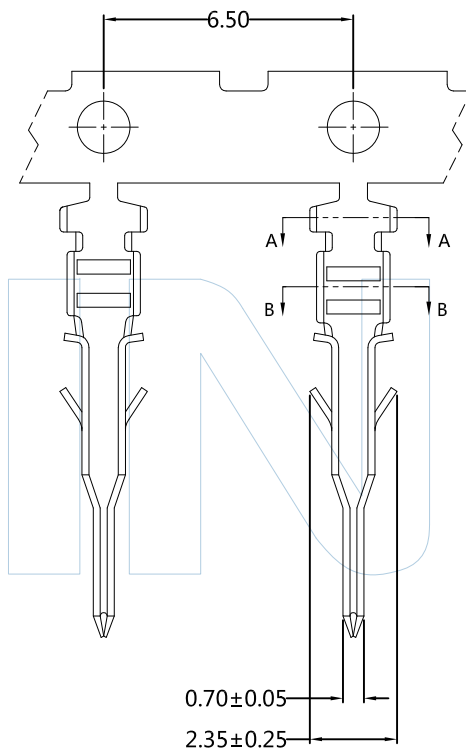

Tel: +86 769 82581808 FAX: +86 769 81766192
E-Mail: sales@winpin.net Http: www.winpin.net

PART NO: T30002-PXX2

TITLE: Molex 3.0mm Male Terminal Connector Series

NOTES:
Current Rating: 5.0AMP
Voltage Rating: 250V AC, DC
Withstand Voltage: 1500V AC/Minute
Contact Resistance: 20mΩ Max
Insulation Resistance: 1000MΩ Min
Operation Temperature: -25°C to +85°C
Applicable Wire: 24~28 AWG
Applicable Housing: H30002-2XXX2

Material:
Contact Material: Phosphor Bronze
Contact Plating: Sn over Ni

UNLESS OTHERWISE SPECIFIED DIMENSIONS ARE IN METRIC TOLERANCES ARE:

DECIMALS Angle
X.X: ±0.40 ± 3°
X.XX: ±0.25
X.XXX: ±0.15

SCALE 1:1
UNIT MM
PROJ. 
SHEET

A0	2015/06/25	NEW	GF.He	Andy	
REV	DATE	MODIFICATION DESCRIPTION	DRAW	CHANGE	APPROVE

PART NUMBER CODING
T30002-P XX 1

Contact plating
SN: Tin

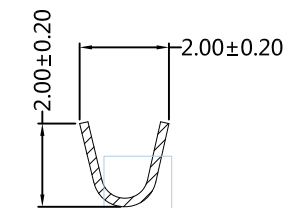
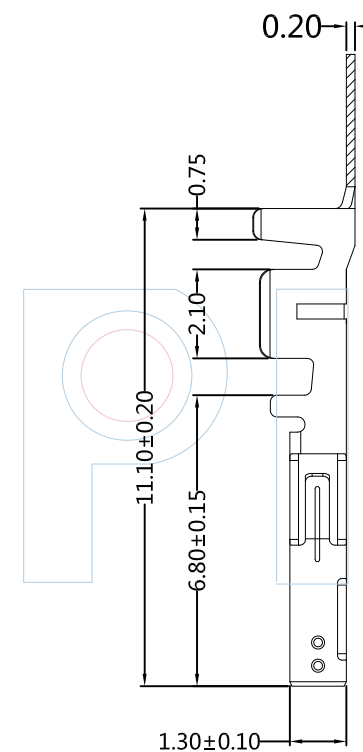
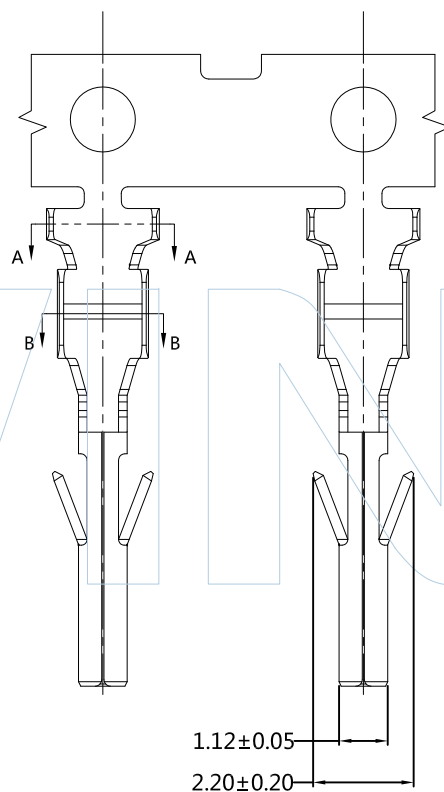

SECTION: B-B

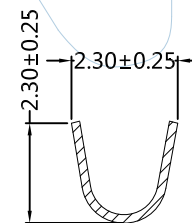

SECTION: A-A



Tel: +86 769 82581808 FAX: +86 769 81766192
E-Mail: sales@winpin.net Http: www.winpin.net

PART NO: T30002-PXX1

TITLE: Molex 3.0mm Female Terminal Connector Series

NOTES:
Current Rating: 5.0AMP
Voltage Rating: 250V AC, DC
Withstand Voltage: 1500V AC/Minute
Contact Resistance: 20mΩ Max
Insulation Resistance: 1000MΩ Min
Operation Temperature: -25°C to +85°C
Applicable Wire: 24~28 AWG
Applicable Housing: H30002-2XXX1

Material:
Contact Material: Phosphor Bronze
Contact Plating: Sn over Ni

UNLESS OTHERWISE SPECIFIED DIMENSIONS ARE IN METRIC TOLERANCES ARE:

DECIMALS Angle
X.X: ±0.40 ± 3°
X.XX: ±0.25
X.XXX: ±0.15

SCALE	1:1
UNIT	MM
PROJ.	
SHEET	

A0	2015/06/25	NEW	GF.He	Andy	
REV	DATE	MODIFICATION DESCRIPTIO	DRAW	CHANGE	APPROVE